

MODEL
S400H
CLASSIC FAC

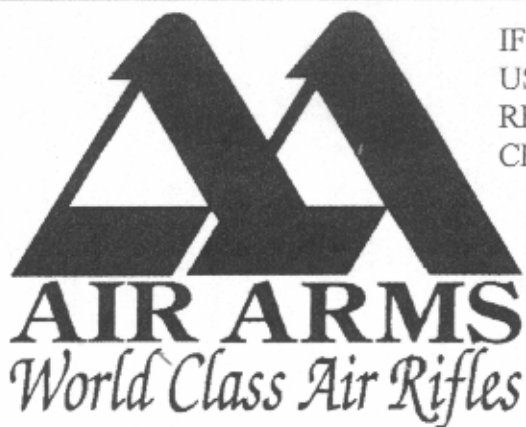

IF IN GREAT BRITAIN, THE
USER OF THIS MODEL
REQUIRES A FIREARMS
CERTIFICATE

USERS HANDBOOK

THIS HANDBOOK REFERS TO S400H CLASSIC FAC MODELS

PLEASE READ THIS MANUAL BEFORE USING YOUR NEW RIFLE, IT CONTAINS IMPORTANT SAFETY INFORMATION AND INSTRUCTION ON ADJUSTMENT AND MAINTENANCE.

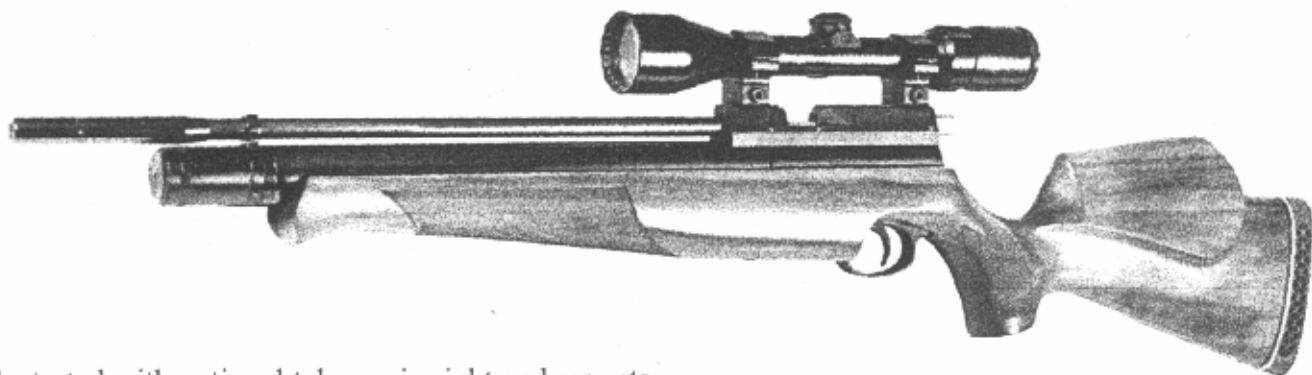

Illustrated with optional telescopic sight and mounts.

HIGH POWER MODELS - OVER 12ft/lbs MUZZLE ENERGY

******* SAFETY CODE *******

- 1 - TREAT THIS AIR RIFLE AS IF LOADED.**
- 2 - NEVER POINT IT AT ANYONE, EVEN IF UNLOADED.**
- 3 - NEVER LEAVE THIS RIFLE UNATTENDED WHEN COCKED OR LOADED.**
- 4 - ALWAYS BE SURE OF WHAT LIES BEYOND YOUR TARGET.**
- 5 - ALWAYS CONDUCT YOURSELF IN A SPORTSMAN-LIKE MANNER.**

ALWAYS BE AWARE THAT YOUR ACTIONS WILL BE UNDER THE SCRUTINY OF OTHER MEMBERS OF THE PUBLIC WHO MAY NOT SHARE YOUR ENTHUSIASM FOR AIR WEAPONS. BAD PRACTICES PROMOTE BAD PUBLICITY. DO NOT JEOPARDISE YOUR FUTURE ENJOYMENT BY MISUSING THIS WEAPON.

WARNING ! - UNAUTHORISED DISASSEMBLY OF THIS RIFLE WILL INVALIDATE THE MANUFACTURERS WARRANTY

IMPORTANT INFORMATION, PLEASE READ

BEFORE LEAVING THE FACTORY THIS RIFLE WAS Q.A. INSPECTED AND TEST FIRED USING AIR ARMS PELLETS TO CHECK OPERATION AND FINAL ADJUSTMENT.

IT WAS DISPATCHED IN A SEALED PURPOSE DESIGNED BOX WITH A CONTENTS LABEL ON THE LID. AIR ARMS MAY NOT BE RESPONSIBLE FOR ANY DAMAGE TO THE CONTENTS OR MISSING ITEMS IF THE BOX IS NOT ORIGINAL, IF IT IS DAMAGED OR THE SEALS ARE NOT INTACT.

AIR ARMS CANNOT BE HELD RESPONSIBLE FOR DAMAGE OR MISSING ITEMS DUE TO TRANSIT DAMAGE, MISHANDLING OR BEING TAMPED WITH AFTER LEAVING THE FACTORY.

IF THIS RIFLE IS NOT RECEIVED IN THE ORIGINAL BOX WITH THE SEALS INTACT, PLEASE EXAMINE CAREFULLY FOR ANY DAMAGE, MISSING TOOLS OR DOCUMENTATION.

IN THE FIRST INSTANCE ANY PROBLEMS OR COMPLAINTS REGARDING THIS PRODUCT SHOULD BE REFERRED TO THE SUPPLIER.

THE AIR CYLINDER IS A HIGHLY PRESSURISED UNIT THAT MUST **NOT** BE MODIFIED IN ANY WAY. SERIOUS PERSONAL INJURY MAY RESULT IF THIS, AND THE ADVICE BELOW IS NOT FOLLOWED.

DO **NOT** PRESSURISE THE CYLINDER IF THERE ARE ANY SURFACE ABRASIONS OR DENTS. CONTACT AIR ARMS FOR ADVICE.

DO **NOT** STORE THE RIFLE IN PLACES WITH, OR NEAR SOURCES OF HIGH TEMPERATURE SUCH AS FIRES OR BOILERS.

DO **NOT** ATTEMPT TO DISMANTLE WHEN PRESSURISED.

DO **NOT** PRESSURISE BEYOND THE STATED FILLING PRESSURE (SEE FILLING INSTRUCTION SECTION). DAMAGE CAUSED BY SUCH ACTION IS **NOT** COVERED BY THE MANUFACTURERS WARRANTY.

ONLY USE CLEAN, FILTERED AND DRY COMPRESSED AIR. **NEVER** USE ANY OTHER GAS, PARTICULARLY INDUSTRIAL OR WELDING GASES SUCH AS OXYGEN, CARBON DIOXIDE, ACETYLENE, HYDROGEN, ARGON, ETC.

IF COMPRESSED AIR IS BEING USED OTHER THAN FROM A DIVING SHOP, THE INSIDE OF THE CYLINDER SHOULD BE INSPECTED FOR CORROSION AT LEAST ANNUALLY. IF IN DOUBT CONTACT AIR ARMS FOR ADVICE.

IN ANY EVENT THE CYLINDER SHOULD BE INSPECTED EVERY TWO TO THREE YEARS DEPENDING UPON USAGE. AIR ARMS CAN PROVIDE THIS SERVICE AT A REASONABLE COST

TO MAINTAIN THIS RIFLE IN GOOD WORKING ORDER IT SHOULD BE SERVICED ANNUALLY BY A COMPETENT GUNSMITH, YOUR SUPPLIER MAY BE ABLE TO PROVIDE THIS SERVICE OR CONTACT AIR ARMS.

A REASONABLE AMOUNT OF ADVICE WILL BE PROVIDED TO ENABLE THE END USER TO SERVICE THEIR OWN RIFLE, HOWEVER THIS IS AT THE DISCRETION OF AIR ARMS AND MAY NOT BE GIVEN IN ALL CASES.

THE VELOCITY OF THIS RIFLE HAS BEEN SET USING AIR ARMS FIELD PELLETS.

THIS MODEL IS A HIGH POWER VERSION THAT REQUIRES THE USER TO HOLD A FIREARMS CERTIFICATE.

CHECKING VELOCITY

- 1 Use a reliable chronograph to check velocity, (the formula below requires the reading to be in feet per second - FPS)
- 2 Use fine measurement scales to weigh the pellet, if scales are unavailable the pellet weight may be stated on the pellet container lid or contact the supplier. (The formula requires the weight to be in grains). To convert from grams to grains multiply by 15.432, i.e. 0.69 grams x 15.432 = 10.65 grains.
- 3 To find the muzzle energy in ft/lbs use the formula $(FPS \times FPS \times Grains) / 450240$, i.e. $(700 \times 700 \times 10.65) / 450240 = 11.59$.

WARNING! IT IS A VERY SERIOUS OFFENCE TO BE IN POSSESSION OF AN AIR RIFLE THAT YOU ARE NOT CERTIFICATED FOR. CONVICTION CAN RESULT IN CONFISCATION OF YOUR RIFLE, A HEAVY FINE OR IMPRISONMENT, EVEN A COMBINATION OF ALL THREE.

IMPORTANT INFORMATION - Continued

DO **NOT** STORE THIS RIFLE IN A DAMP PLACE SUCH AS GARDEN SHED OR GARAGE.

DO **NOT** STORE THIS RIFLE IN A PLASTIC OR PVC GUN BAG WITHOUT FIRST APPLYING A SURFACE CORROSION INHIBITOR.

ALWAYS ENSURE THE LOADING BOLT IS FULLY CLOSED BEFORE FIRING.

******* LIMITED LIABILITY WARRANTY *******

THIS PRODUCT IS WARRANTED TO THE RETAIL CUSTOMER FOR 12 MONTHS FROM DATE OF PURCHASE AGAINST DEFECTS IN MATERIALS AND WORKMANSHIP AND IS TRANSFERABLE TO ANY SUBSEQUENT OWNER.

PROOF OF PURCHASE IS REQUIRED TO RECEIVE WARRANTY REPAIRS, RETAIN YOUR PURCHASE INVOICE AND RETURN THE WARRANTY REGISTRATION CARD AS SOON AS POSSIBLE AFTER PURCHASE. THE WARRANTY CARD MUST SHOW THE DEALER/SUPPLIER NAME AND ADDRESS AND DATE OF PURCHASE.

WHAT IS COVERED

REPLACEMENT PARTS & LABOUR ON A 'BACK TO BASE' BASIS, RETURN TRANSPORTATION TO THE CONSUMER (MAINLAND UK ONLY).

WHAT IS NOT COVERED

TRANSPORTATION FROM TO CONSUMER TO AIR ARMS.

DAMAGE CAUSED BY MISUSE, ABUSE, LACK OF ROUTINE MAINTENANCE, TRANSIT DAMAGE BETWEEN THE DEALER/SUPPLIER AND THE CONSUMER OR UNAUTHORISED DISASSEMBLY.

PARTS SUBJECT TO NORMAL WEAR AND TEAR.

ANY OTHER CONSEQUENTIAL COST INCURRED BY THE CONSUMER.

RETURN TRANSPORTATION TO CONSUMERS OUTSIDE MAINLAND UK.

NO WARRANTY IS IMPLIED AS TO THE FITNESS FOR ANY PARTICULAR PURPOSE.

AIR ARMS RESERVE THE RIGHT TO ALTER THE CONSTRUCTION, APPEARANCE OR PERFORMANCE OF ANY PRODUCT WITHOUT PRIOR NOTIFICATION. ALL ILLUSTRATIONS ARE FOR INFORMATION PURPOSES ONLY AND DO NOT NECESSARILY SHOW THE EXACT MODEL THAT WAS PURCHASED.

GENERAL MAINTENANCE AND LUBRICATION

MAINTENANCE

FIXINGS

REGULARLY CHECK THE TIGHTNESS OF ALL FIXINGS. HOWEVER DO **NOT** BE TEMPTED TO OVER TIGHTEN AS SOME PARTS ARE MADE FROM ALUMINIUM AND STRIPPED THREADS MAY RESULT. STRIPPED THREADS ARE NOT COVERED BY THE MANUFACTURERS WARRANTY.

BARREL

FOR ULTIMATE ACCURACY, CLEAN AND RE-LUBE THE BARREL FREQUENTLY. IT IS DIFFICULT TO ADVISE HOW OFTEN IS BEST FOR EVERY CIRCUMSTANCE, BUT EVERY 250 SHOTS IS NOT TOO OFTEN IF THE DESIRE IS TO KEEP THE BARREL IN THE BEST POSSIBLE CONDITION.

THE CORRECT MATERIALS ARE VERY IMPORTANT. AIR ARMS ONLY USES PRODUCTS MADE BY NAPIER. LISTED BELOW IS THE NAPIER PRODUCT AND A MORE GENERALLY AVAILABLE ALTERNATIVE. IF POSSIBLE USE NAPIER FOR THE BEST RESULTS.

CLEANER : 'NAPIER GUN CLEANER', ALTERNATIVELY WHITE SPIRIT.

OIL : 'NAPIER GUN OIL', ALTERNATIVELY '3 IN 1' OIL.

PULL-THROUGH PAD : 'NAPIER RIFLE CLEAN', ALTERNATIVELY SOFT COTTON CLOTH.

PULL-THROUGH LINE : 20lb FISHING LINE

AS A RULE CLEANERS AND OILS INTENDED FOR SHOTGUNS AND SMALL/FULLBORE WEAPONS ARE NOT SUITABLE.

- 1 CUT A PIECE OF LINE THREE TIMES THE LENGTH OF YOUR BARREL, FOLD IN HALF AND TIE ENDS TOGETHER. REMOVE SILENCER IF FITTED. OPEN LOADING BOLT.
- 2 FEED UN-KNOTTED END DOWN BARREL FROM THE MUZZLE END UNTIL FOLDED END PROTRUDES ABOUT 50mm.
- 3 CUT A 100mm LENGTH OF 'RIFLE CLEAN' OR 100x50mm PIECE OF CLOTH AND PASS IT BETWEEN THE PROTRUDING LOOP. SPRAY THE PAD WITH 'GUN CLEANER' OR WHITE SPIRIT, TURN THE RIFLE UPSIDE DOWN AND PULL THE LINE BACK THROUGH THE BARREL SLOWLY.
- 4 REPEAT STEPS 2&3 UNTIL THE PAD IS CLEAN.
- 5 REPEAT STEPS 2&3 ONCE MORE WITHOUT ANY CLEANER ON THE PAD TO DRY THE BARREL.
- 6 REPEAT STEPS 2&3 ONCE MORE WITH THE PAD SPRAYED WITH 'GUN OIL' OR 3 IN 1 OIL.

IMPORTANT : THE REASON FOR TURNING THE RIFLE UPSIDE DOWN IS TO PREVENT EXCESS CLEANER/OIL FROM PASSING DOWN THE TRANSFER PORT INTO THE FIRING VALVE CHAMBER.

LUBRICATION

LUBRICATION OF THE INTERNAL MECHANISM IS NOT COVERED IN THIS HANDBOOK. THIS IS BEST PERFORMED BY A COMPETENT GUNSMITH OR THE FACTORY AND IN ANY CASE SHOULD NOT BE REQUIRED UNTIL THE ANNUAL SERVICE.

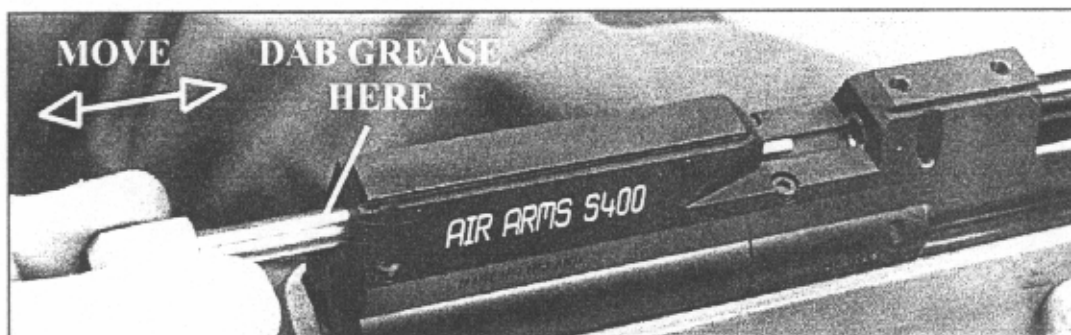

APPLY A SMALL DAB OF GREASE ON THE LOADING BOLT AND WORK-IN BY MOVING THE BOLT FORWARDS AND BACKWARDS. WIPE OFF EXCESSIVE GREASE. PREFERRED GREASE IS 'NAPIER G95 GUN GREASE'

ON RETURN FROM EVERY SHOOTING SESSION, WIPE ALL OVER THE EXTERIOR WITH AN OILY RAG TO PRESERVE THE SURFACE FINISH DURING STORAGE.

OPERATING INSTRUCTIONS

COCKING

HOLD SECURELY IN ONE HAND AND WITH THE OTHER TURN THE LOADING BOLT AND PULL BACKWARDS UNTIL THE FIRST RESTRICTION IS FELT. PULL BACK FURTHER UNTIL THE TRIGGER MECHANISM ENGAGES. THIS CAN BE DETERMINED BY THE TRIGGER BLADE 'KICKING' FORWARD AT THE END OF THE COCKING STROKE.

IF THE BOLT IS GRIPPED AS IN THE ILLUSTRATION WITH THE THUMB ON THE OTHER SIDE OF THE BOLT KNOB, THE COCKING ACTION IS MUCH SMOOTHER.



LOADING

INSERT A PELLET INTO THE LOADING GROOVE AS IN THE ILLUSTRATION. PUSH THE LOADING BOLT RIGHT THE WAY FORWARD AND AT THE END OF THE STROKE TURN UNTIL LOCKED.

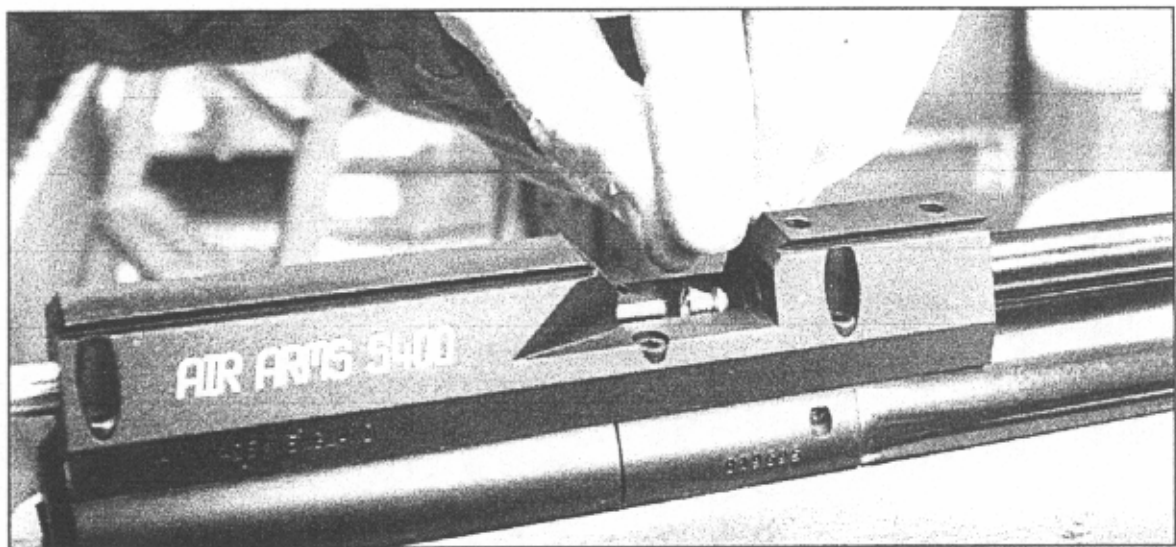

THE RIFLE IS NOW COCKED AND LOADED, TREAT WITH CAUTION.

TRIGGER ADJUSTMENTS

THE S400 & S410 MODELS ALL HAVE THE SAME TRIGGER MECHANISM. IT IS A TWO STAGE UNIT WITH ADJUSTMENT TO BOTH STAGES PLUS A WEIGHT OF PULL ADJUSTMENT. IT IS EASY TO UPSET THE BALANCE BETWEEN THE TWO STAGES AND MAKE THE TRIGGER INOPERABLE IF INCORRECTLY ADJUSTED.

IF YOU HAVE NO EXPERIENCE OF ADJUSTING TWO STAGE TRIGGERS SEEK GUIDANCE OR LEAVE THE TRIGGER AS SET BY THE FACTORY.

NOTE ! INCORRECTLY ADJUSTED TRIGGER MECHANISMS ARE NOT COVERED BY THE MANUFACTURERS WARRANTY. IT IS NOT POSSIBLE TO TEST THIS RIFLE WITH A INCORRECTLY ADJUSTED TRIGGER, THEREFORE ALL TRIGGERS LEAVE THE FACTORY WITH CORRECT ADJUSTMENT.

WARNING ! AN INCORRECTLY ADJUSTED TRIGGER CAN MAKE THE RIFLE UNSAFE TO HANDLE.

DESCRIPTION OF OPERATION

THE S400/410 RIFLES HAVE A TRUE TWO STAGE TRIGGER MECHANISM. THIS MEANS THAT AS THE TRIGGER IS PULLED THE BOTTOM SEAR GRADUALLY DISENGAGES WITH THE TOP SEAR UNTIL THE TWO DISENGAGE COMPLETELY AND THE RIFLE GOES OFF. IF THE PRESSURE ON THE TRIGGER IS RELEASED AT ANY POINT BEFORE FULL DISENGAGEMENT, THE BOTTOM SEAR WILL AUTOMATICALLY RETURN BACK TO FULL ENGAGEMENT. THIS TYPE OF TRIGGER ALLOWS VERY FINE BUT SAFE OPERATION BECAUSE IT IS THE RELEASE OF THE 2ND STAGE THAT ACTUALLY MAKES THE RIFLE FIRE. THIS ARRANGEMENT IS VASTLY SUPERIOR TO PSEUDO TWO STAGE TRIGGERS WHERE THE FIRST STAGE IS JUST A PIVOTING TRIGGER BLADE THAT DOES NOT MOVE SEARS. THE DOWN SIDE IS THAT THEY ARE MORE DIFFICULT TO ADJUST CORRECTLY.

ADJUSTMENT

THERE ARE THREE ADJUSTER SCREWS, A-B-C.

THE WEIGHT OF PULL ADJUSTER (A) IS LOCATED IN THE FRONT OF THE TRIGGER GUARD. CLOCKWISE ROTATION INCREASES PULL WEIGHT. IF ADJUSTED TOO FAR THE SPRING WILL BECOME COIL-BOUND AND PREVENT TRIGGER OPERATION.

THE SECOND STAGE ADJUSTER (B) IS THE REAR SCREW LOCATED IN THE TRIGGER BLADE. THIS SCREW DETERMINES THE EXACT POINT THAT THE 2ND STAGE STARTS. IF THE 1ST STAGE SCREW IS INCORRECTLY ADJUSTED THIS SCREW MAY NOT HAVE ANY EFFECT.

THE FIRST STAGE ADJUSTER (C) IS THE FRONT SCREW LOCATED IN THE TRIGGER BLADE. THIS SCREW DETERMINES THE LENGTH OF TRAVEL BEFORE THE 2ND STAGE STARTS. CLOCKWISE ADJUSTMENT REDUCES THE FIRST STAGE TRAVEL.

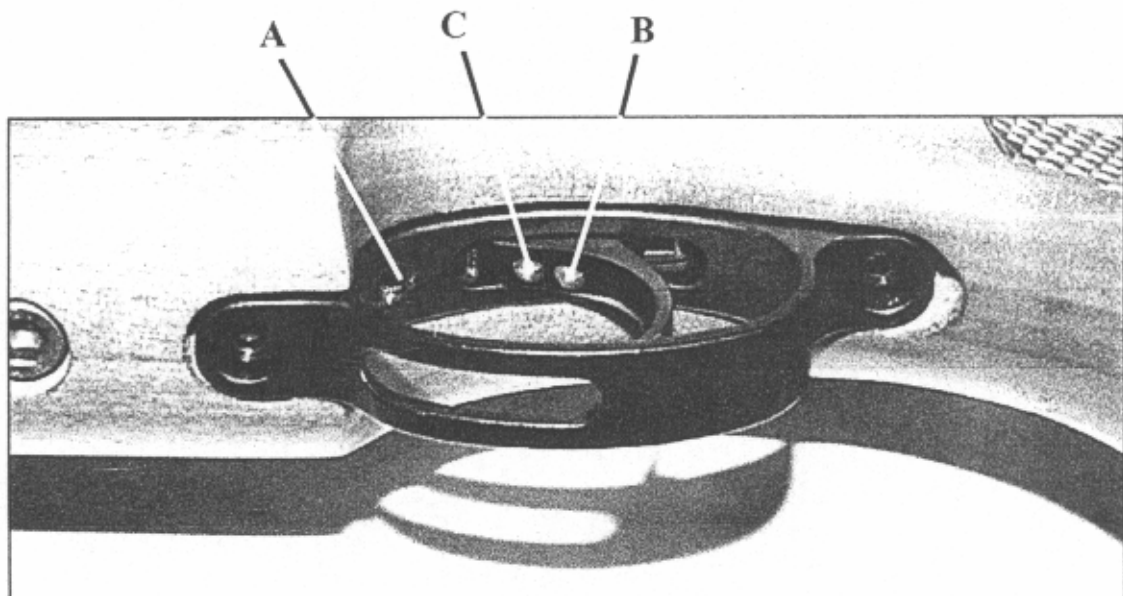

FILLING INSTRUCTIONS

NOTE ! ONLY USE CLEAN, FILTERED AND DRY COMPRESSED AIR, PREFERABLY FROM A DIVING SHOP. OVER PRESSURISATION WILL DAMAGE THE CYLINDER BEYOND REPAIR.

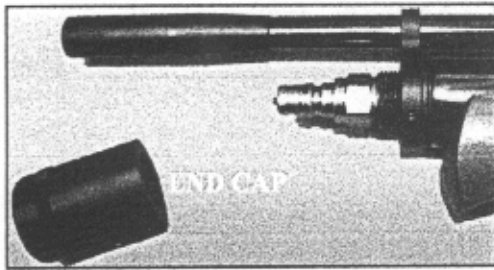

- 1 REMOVE END CAP BY TURNING ANTICLOCKWISE.

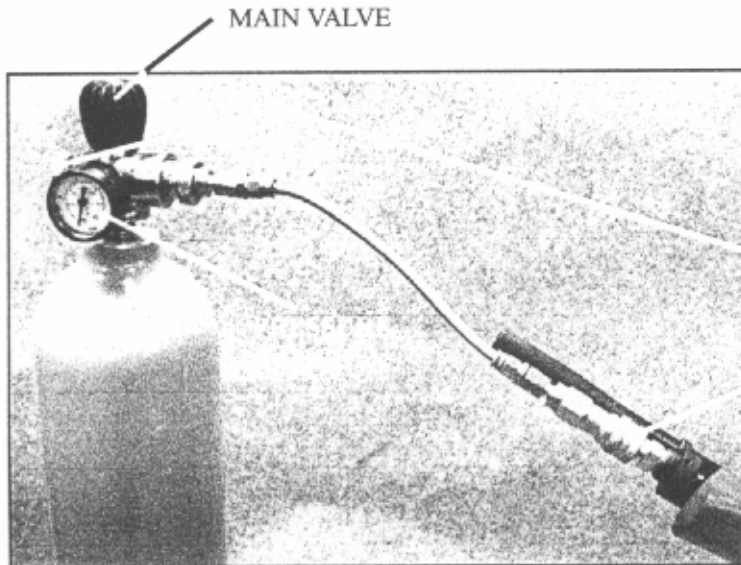

- 2 IF THE CYLINDER IS EMPTY, COCK THE MECHANISM AS DESCRIBED ON PAGE 4.
- 3 CHECK THAT THE BLEED VALVE IS CLOSED. TURN CLOCKWISE TO CLOSE.
- 4 PULL THE RELEASE RING BACK ON THE FEMALE CONNECTOR AND PUSH IT ONTO THE MALE CONNECTOR FITTED TO THE RIFLE.

- 5 SLOWLY OPEN THE MAIN VALVE (ANTICLOCKWISE) AND OBSERVE THE PRESSURE GAUGE. WHEN THE CORRECT FILLING PRESSURE IS OBSERVED, (SEE BELOW) CLOSE THE MAIN VALVE (CLOCKWISE). BE VERY CAREFUL NOT ALLOW THE PRESSURE IN BOTH CYLINDERS TO EQUALISE IF THE DECANTING CYLINDER HAS MORE PRESSURE THAN THE RIFLE CYLINDER.
- NOTE !, AT LEAST 50 BAR (725psi) IS REQUIRED IN THE CYLINDER BEFORE THE FIRING VALVE FULLY SEALS. AIR MAY ESCAPE FROM THE BARREL UNTIL THIS PRESSURE IS REACHED.
- 6 OPEN BLEED VALVE (ANTICLOCKWISE) TO RELEASE THE AIR FROM THE CONNECTING HOSE.
- 7 PULL BACK THE RELEASE RING ON THE FEMALE CONNECTOR AND REMOVE FROM MALE CONNECTOR.
- 8 REPLACE END CAP, DO NOT OVER-TIGHTEN.

THE S400 HAS A PRESSURE INDICATOR MOUNTED UNDER THE STOCK FORE END. THIS PROVIDES A VISUAL CHECK ON THE AMOUNT OF REMAINING AIR IN THE CYLINDER. THERE ARE TWO TYPES OF GAUGE THAT MAY BE FITTED. ONE HAS COLOUR GRADUATIONS THE OTHER HAS NUMERIC. IN BOTH CASES THE GRADUATIONS INDICATE 0 TO 250 BAR. **DO NOT FILL TO THE REQUIRED PRESSURE BY WATCHING THIS INDICATOR. THE NEEDLE REACTION SPEED HAS BEEN SLOWED TO PREVENT DAMAGE WHILST FILLING AND TAKES TIME TO SYNCHRONISE TO THE ACTUAL PRESSURE IN THE CYLINDER.**

IN THE INTERESTS OF SAFETY THE RIFLE CYLINDER HAS A BLOW-OUT DEVICE THAT OPERATES AT APPROXIMATELY 250BAR. ONCE OPERATED (INDICATED BY DEFORMATION OF THE CYLINDER END) THE CYLINDER IS BEYOND FURTHER USE AND MUST BE REPLACED.

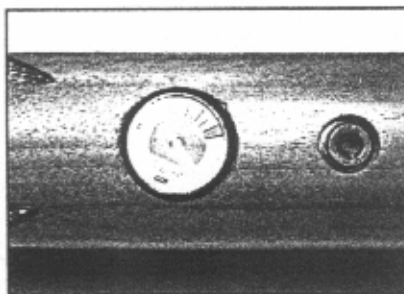

FILLING PRESSURES

4.5mm/.177 cal	200 BAR
5.5mm/.22 cal	200 BAR

NOTE !

FILLING TO HIGHER PRESSURES WILL **NOT** INCREASE POWER AND MAY PREVENT OPERATION COMPLETELY OR CAUSE CYLINDER DAMAGE.

FILLING TO LOWER PRESSURES WILL NOT REDUCE POWER ONLY THE NUMBER OF SHOTS.

PARTS ILLUSTRATION ◊ S400-H

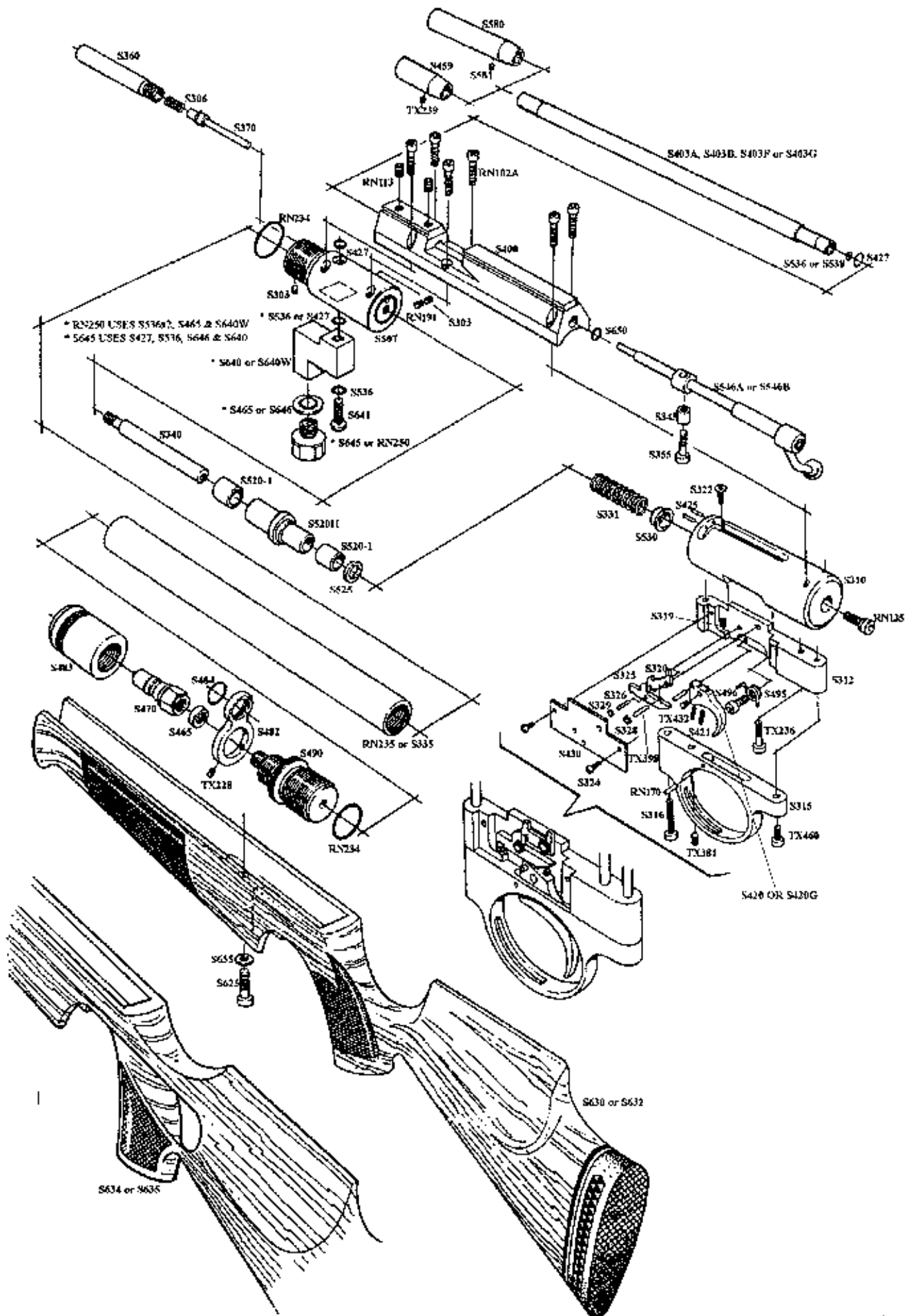

PARTS LIST <> S400-H

RN102A	BOLT HOUSING FIXING SCREW	S459	MUZZLE END
RN113	BARREL FIXING SCREW	S459S	MUZZLE END FOR OPEN SIGHTS
RN135	BODY LOCATION SCREW	S465	BONDED SEAL
RN170	TRIGGER STOP PIN	S468	FEMALE SNAP CONNECTOR
RN191	TRANSFER PORT ADJUSTER	S470	MALE SNAP CONNECTOR
RN234	SEALING RING	S482	FRONT CYLINDER CLAMP
RN235	CYLINDER TUBE (CARBINE)	S483	CYLINDER END CAP
RN250	PRESSURE INDICATOR GAUGE	S484	FRONT CLAMP RING
S298	VENTURI ADJUSTER SCREW	S490	FILLING VALVE BODY
S303	LOCKING SCREW	S495	TOP SEAR SPRING
S306	FIRING VALVE SPRING	S496	SPRING SCREW
S310	STRIKER BODY	S507	FIRING VALVE BODY
S312	TRIGGER CHASSIS	S520H	STRIKER
S315	TRIGGER GUARD	S520-1	STRIKER BUSH
S318	TRIGGER GUARD SCREW	S525	MAIN SPRING SPACER
S319	TRIGGER WEIGHT OF PULL SPRING	S530	MAIN SPRING GUIDE
S320	TOP SEAL	S536	BARREL (.177) & GAUGE MOUNT SEAL
S322	TRIGGER CHASSIS SCREW	S538	BARREL SEAL (.22)
S324	TRIGGER CHASSIS COVER SCREW	S546A	LOADING BOLT ASSEMBLY .177
S325	BOTTOM SEAR	S546B	LOADING BOLT ASSEMBLY .22
S326	TRIGGER CHASSIS PIN (SMALL)	S580	SOUND MODERATOR
S328	CHASSIS PIN SPACER (LARGE)	S581	MODERATOR SCREW
S329	CHASSIS PIN SPACER (SMALL)	S625	STOCK SCREW
S331	MAIN SPRING	S630	BEECH STOCK RH
S335	CYLINDER TUBE (STD)	S632	WALNUT STOCK RH
S340	STRIKER GUIDE ROD	S634	WALNUT THUMBHOLE STOCK RH
S345	LOADING BOLT SCREW SLEEVE	S635	WALNUT THUMBHOLE STOCK LH
S355	LOADING BOLT SCREW	S640	PRESSURE GAUGE MOUNT FOR S645
S360	FIRING POT	S640W	PRESSURE GAUGE MOUNT FOR RN250
S370	FIRING VALVE ASSEMBLY	S641	GAUGE MOUNT SCREW
S400	BOLT HOUSING	S645	PRESSURE INDICATOR GAUGE
S403A	BARREL .22 (STD)	S646	PRESSURE GAUGE SEAL FOR S645
S403B	BARREL .177 (STD)	S650	LOADING BOLT BUFFER
S403F	BARREL .22 (CARBINE)	S655	STOCK SCREW WASHER
S403G	BARREL .177 (CARBINE)	TX228	CYLINDER CLAMP SCREW
S420	TRIGGER BLADE	TX236	CHASSIS SCREW
S420G	TRIGGER BLADE (THUMBHOLE VER.)	TX239	MUZZLE END SCREW
S421	TRIGGER ADJUSTER SCREW	TX381	TRIGGER WEIGHT OF PULL ADJ SCREW
S425	LOADING BOLT HANDING PIN	TX398	CHASSIS PIN (LARGE)
S427	BOLT HOUSING/BODY SEAL	TX432	TRIGGER ADJ SCREW LOCKING PAD
S430	TRIGGER CHASSIS COVER PLATE	TX460	TRIGGER CHASSIS SCREW

PLEASE STATE YOUR RIFLE NUMBER IN ANY CORRESPONDENCE.

**This owner's manual was
provided as a service to you
by:**



www.airgunsofarizona.com

airguns_az@yahoo.com

Phone: (480)461-1113

Fax: (480)461-3928